

# CCS6T

## High Performance Closed-Back Ceiling Speaker



1

### FEATURES

- Time tested metal grille with hardware free appearance
- Clamp-on mounting system for fast and easy installation
- Designed for maximum bass output even at low volume
- Sealed speaker/backbox assembly
- Dual 70.7/100V Xfrmr with dial wattage selection on front
- Phoenix terminal block connection

### DESCRIPTION

The Penton Audio USA CC S6T was designed for high-end audio installation where full impact bass output along with high sound pressure levels is imperative. The speaker component is situated in a sealed metal back-box with a UL Plenum compliant wire connection on the back of the back-box. Installer friendly phoenix style terminal blocks quickly and easily connect to the speaker and also offers a pass-through connection for continuing the line to other speakers in the system.

The unit uses a 6" long throw low frequency driver along with a 1" tweeter mounted on axis for single point sound output. A bass port on the front of the baffle serves to further extend the low frequencies of this speaker. Transformer selection is completed via a screwdriver adjustable dial on the front of the baffle easily accessible by removing the grille. With a maximum 60 Watts transformer tap selection this speaker offers unique sonic qualities along with a substantial sound pressure level.

### APPLICATION

The CCS6T is an excellent choice for any type of background music application and a good choice for many foreground music applications as well. Upscale restaurants, sports clubs, hotels, malls, and any other location where high-quality audio is desired will find the CC S6T to be a very attractive choice. With its low profile it is also a great choice for boardrooms and other venues where high quality sound is imperative, but the visual aspects of the speaker are equally important.

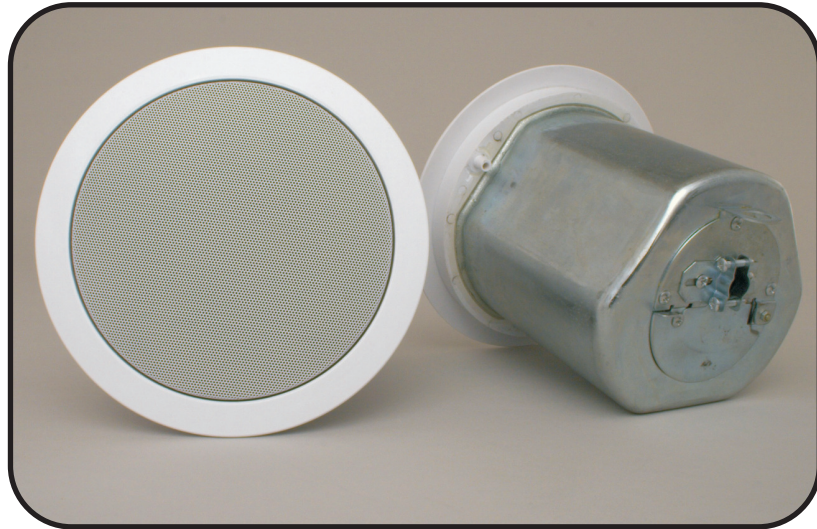

### SPECIFICATIONS

Cone speaker size:  
6"

Frequency Response:  
60Hz - 20kHz +/- 5 dB

Power handling (raw driver)  
90 watts

SPL @ 1w 1m  
89 dB  
Dispersion @ 1 kHz  
130

Speaker design:  
Coaxial

Tweeter Type:  
1" titanium dome with 1/2" moving coil  
and neodymium magnet

Cone Material (driver)  
Polypropylene with rubber surround

Magnet Weight:  
80 oz

Transformer max insertion loss:  
0.6 dB

Transformer Tap Change:  
Screwdriver adjustable dial

Connection:  
Detachable Phoenix style terminal block

70.7V Transformer Taps:  
60, 30, 15, 7.5

100 V Transformer Taps:  
60, 30, 15

Mounting:  
Quick connect Flip-Out and Tighten  
Connectors

Baffle Material:  
High-Impact PVC

Finish:  
White

Suggested Mounting Accessories:  
CBG06 Tile Bridge

Dimensions:  
Front: 10 1/8" total, 9", 6 3/4" cutout  
Depth Required: 7"

Net Weight (lbs)  
7.7 lbs

# CCS6T

## ARCHITECTS' AND ENGINEERS' SPECIFICATIONS:

Unit shall be Penton Audio USA Model CCS6T or approved equal. Assembly shall be comprised of a coaxial 6" loudspeaker with 80 Oz magnet and a 1" titanium tweeter with a 1/2" moving coil and neodymium magnet. It shall also have a pre-mounted dual wattage transformer in a sealed enclosure with UL Plenum compliant wire terminations.

Baffle shall be round with inner mesh grille. Installation shall be by quick connect flip-out and tighten connectors

Loudspeaker shall have a 130 dispersion pattern and a smooth frequency response ranging from 60Hz to 20kHz +/- 5dB. Sensitivity shall be a minimum of 86dB @ 1 watt 1 meter.

Transformer shall be pre-mounted with wattage selection of 7.5, 15, 30, and 60 watts. Tap selection shall be done via screwdriver adjustable dial on front of the baffle assembly. Insertion loss shall not exceed 0.6dB

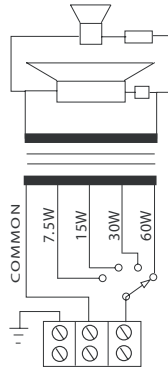

Circuit Diagram

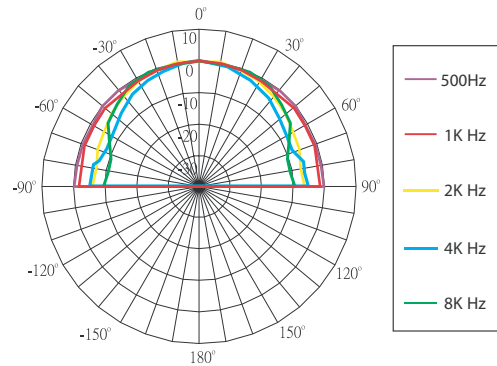

Polar Pattern

EASE and CATT data are available on request

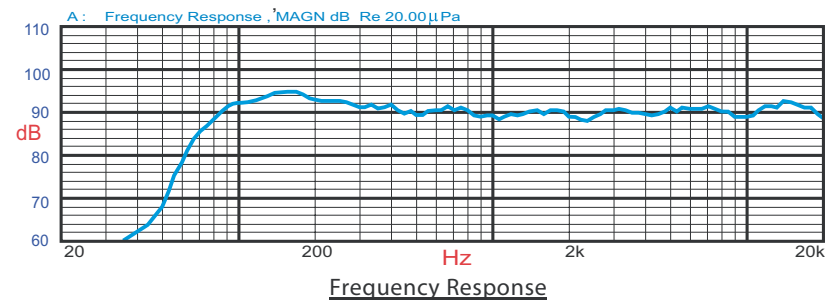
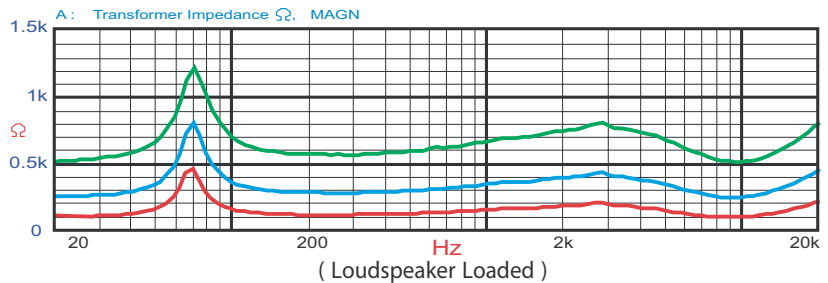

unit: mm

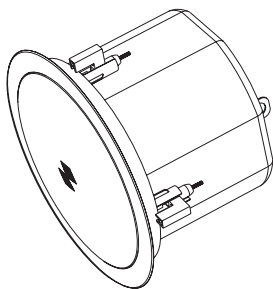

Isogonal View

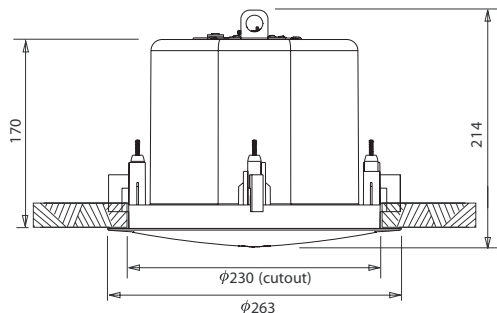

Side View

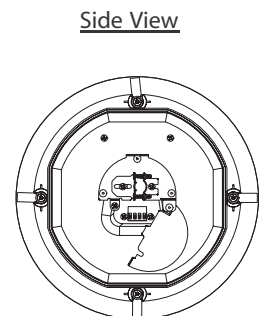

Rear View